

Platinum Lock Datasheet



Table of contents

Introduction	2
Images	2
Technical Specifications	2
Dimensions	3
Latch Specifications	3
Drilling Diagram	4
Handle Dimensions.....	4
Mechanical Key.....	4

Introduction

The Platinum is modern lock that appeals to the modern environment. It is a feature rich and durable lock hardware perfectly suitable to any type of accommodation site.

Supports the latest technologies including:

- RFID technology
- Mobile Access
- Sub-1 GHz wireless connectivity

Images





Technical Specifications

Door thickness	34 - 55 mm thickness
RFID Specifications	13.56MHz Technology ISO 14443A (MIFARE)
Wireless Technologies	Bluetooth Low Energy (BLE) Smart 4.0, Sub-1 915MHz Wireless Connectivity
Working Voltage	DC 4.5V, (3 x AA alkaline batteries)
Limited Voltage	DC 3.0V
Working Temp	-20 to 60 Degrees Celsius
Working Humidity	20% - 90%
Emergency Power Supply	Not applicable (Battery Case accessible from the outside)
Card Read Time	<0.8s
Warnings	Low battery warning function
User interface	2 coloured LED display (green, red) with buzzer
Keypad Display	N/A
Battery location	Outside of the room
Privacy snib	90 degree rotation
Material	Body: 304 Stainless steel, Reader: High quality plastic
Weather resistant	Rubber gaskets for water tight protection (IP Rating in progress)
Handle direction	Not reversible - Left handle and Right handle selection required
Mechanical key override	2 x unique mechanical keys (supplied per lock)
Certifications	Fire rated to AS standards (up to 2-4 hours)

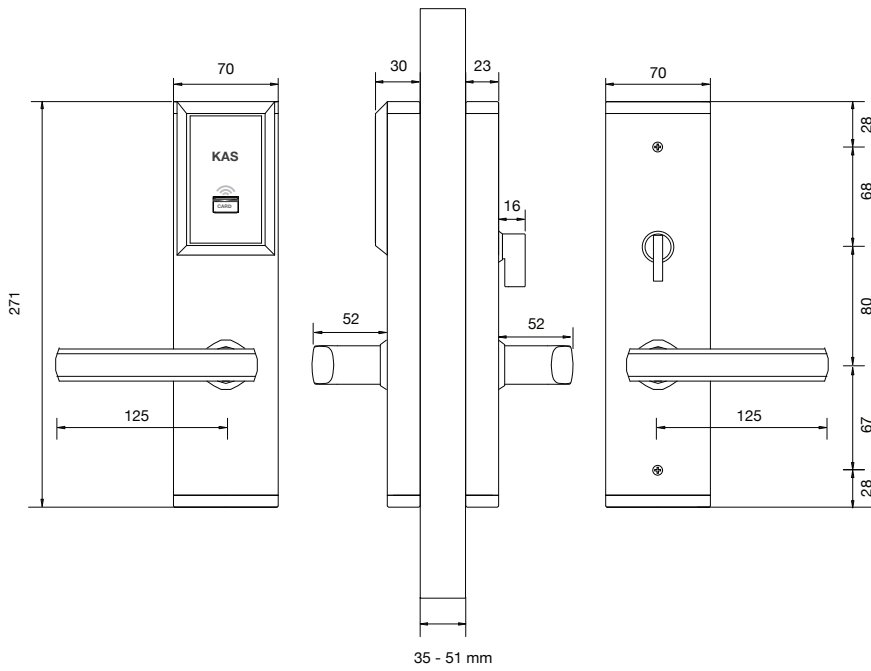
Dimensions

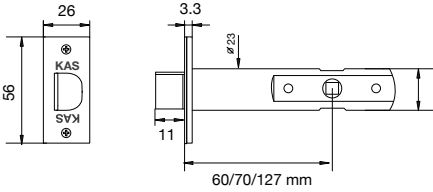
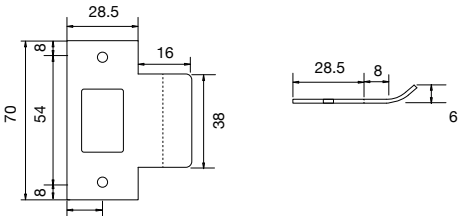

Latch Specifications

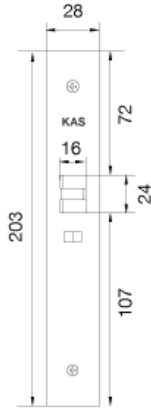
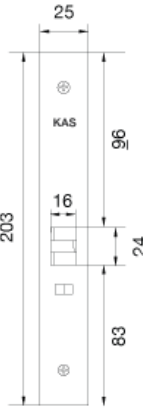
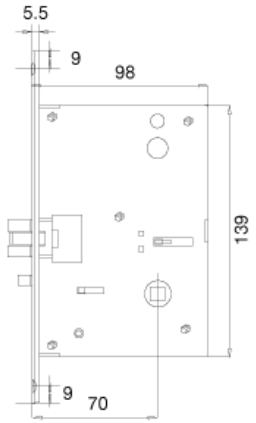
<p>Tubular Latch</p> 	<p>Latch Dimensions</p> 	<p>Strike Plate</p> 
<p>Mortise Latch</p> 	<p>ML-V</p>  <p>ML-S</p> 	

Drilling Diagram

TL-Tubular Latch

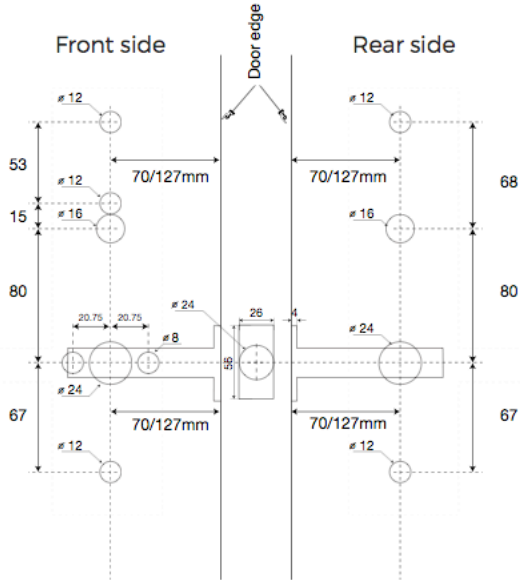

ML-Mortise Latch
MODEL: ML-V

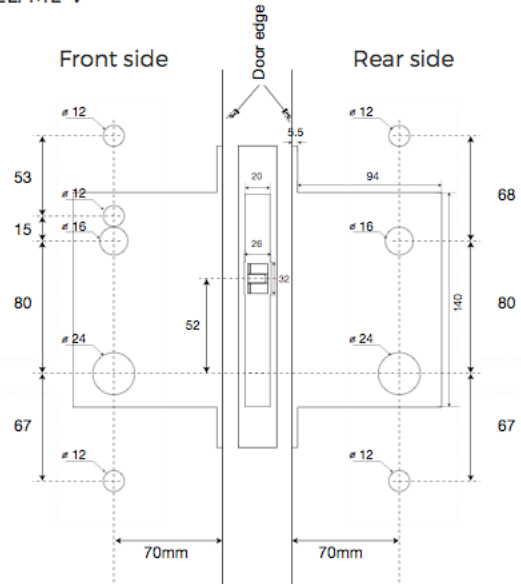

Handle Dimensions

Platinum has one handle type to suit all purposes.

Clearance

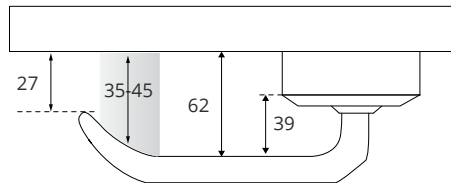

Handle Grip Curve

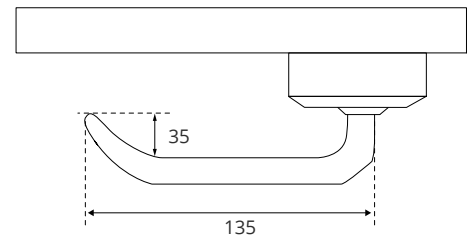

Mechanical Key



Platinum Lock has a concealed mechanical key barrel for emergency override. In the case of electronics malfunction the mechanical keys can open the door.

- 2 x mechanical keys per lock